



48x48mm

Ordering Information

MA501

Terminal Connections

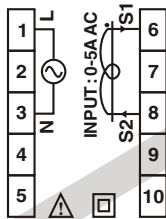

Dimensions (in mm)

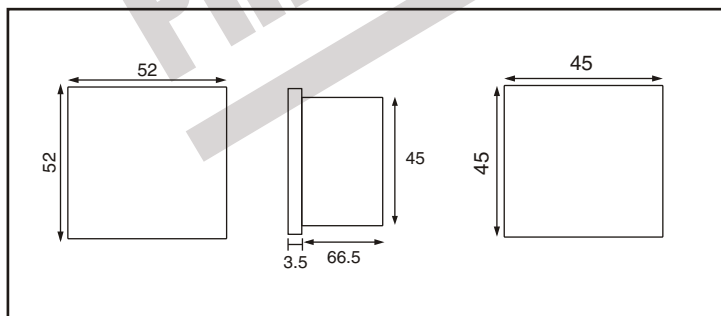

FEATURES

- 4 Digit, Liquid Crystal Display
- Analog style bargraph indication
- True RMS measurement
- CT programable up to 5000A
- 1 phase 2 wire electrical connection
- IP protection (Front Plate): IP65

Technical Specifications

PARAMETER

Electrical Connection	1 phase 2 wire
CT Primary Setting	5, 10, 20, 30, 40,50, 60, 75, 80,100,150, 175, 200, 250, 300, 400, 500,600, 630, 800, 1000, 1200, 1500,1600, 2000, 2250,2500, 3000, 3200, 4000, 5000. (Default setting : 5A AC)

CT Secondary	5A
Input Range	0 - 5A AC
Measurement Range	0 - 6.2A AC
Accuracy	± 0.5% of CT primary setting.

DISPLAY

Display	4 digit
Overrange Indication	"Or" for input > 6.2A AC
Display range	0 - 6200A
Bargraph	Analog style Bargraph indication

GENERAL SPECIFICATION

Auxiliary supply voltage (Vn)	240V AC ± 20%
Supply Frequency	50/60 Hz
Operating temperature	-20 to 60 C
Storage temperature	-30 to 80 C
Humidity (non-condensing)	90% RH
Protection Level	IP65 for faceplate